

Data Sheet



Article number: 20147008

Description: E+G Stainless Steel-Ball lock pin
GN 113.1-10-0

Measures

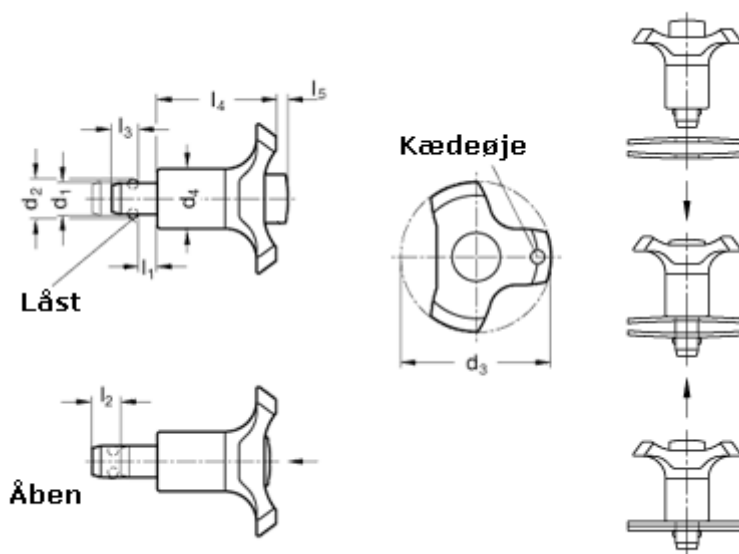

Bore diameter = 10

d1 = 10

d2 = 12

d3 = 47

d4 = 23

l1 = 0 til 5mm

l2 = 5

l3 = 8,7

l4 = 36

l5 = 4

Resilience (N) = 21 / 23